

ITEM	SIZE	SUGGESTED FUNCTION
1	2"	SPARE
2	2"	FILL
3	1/2"	DRAIN FOR SPILLBOX
4	7 GAL.	SPILLBOX, DWG."SBB002"
5	2"	PRIMARY TANK WORKING VENT
6	2"	MECHANICAL GAUGE/SPARE
7	4"	PRIMARY TANK EMERGENCY VENT
8	2"	RETURN
9	2"	SUPPLY
10	SMALL	LIFTING LUG
11	4"	SECONDARY CONTAINMENT EMERGENCY VENT
12	2"	SECONDARY MONITOR PORT
13	2"	SECONDARY WORKING VENT

**TANK SPECIFICATIONS**

VENTING CAPACITY: PRIMARY TANK - 42,100 CUBIC FEET PER HOUR  
SECONDARY TANK - 52,700 CUBIC FEET PER HOUR

MATERIAL: PRIMARY TANK - 10 GA.  
SECONDARY TANK - 10 GA.

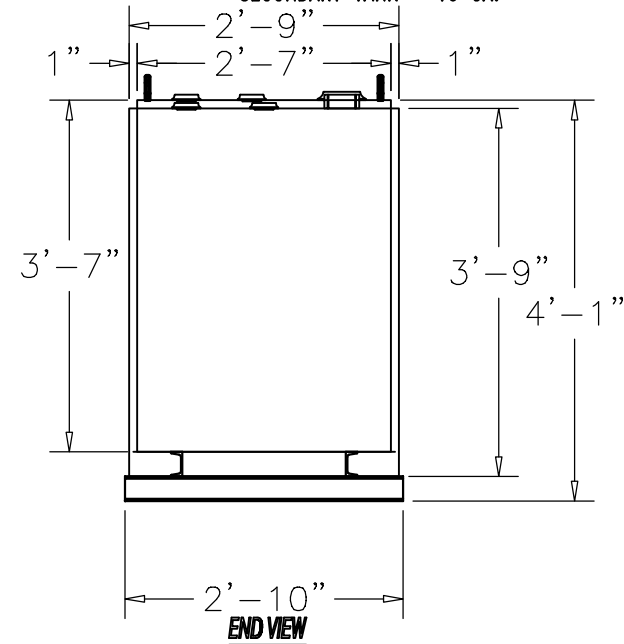
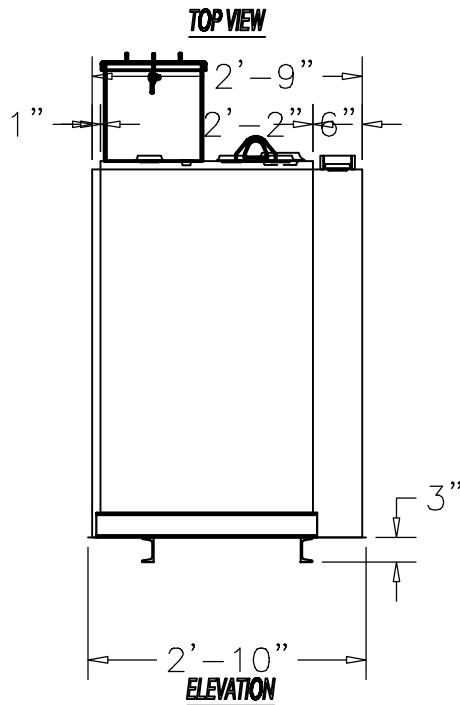

PRODUCT CODE	GALLONS	DESCRIPTION	OVERALL SIZE	SHIP WT.
GCAA1150DS001	150	UL-142 DOUBLE WALL GEN CUBE TANK W/SPILLBOX	2'-10" L X 2'-10" W X 4'-1" H	645 LBS.

**CONTAINMENT SOLUTIONS®**

THIS DRAWING AND DESIGN SHOWN HEREIN IS THE PROPERTY OF CONTAINMENT SOLUTIONS. USE OR COPIES THEREOF CANNOT BE MADE WITHOUT WRITTEN CONSENT.

CUSTOMER NAME: \_\_\_\_\_  
**APPROVED** BY: \_\_\_\_\_ DATE: \_\_\_\_\_

DRAWN BY: D. ROVANG DATE DRAWN: 01-01-17  
 DWG NUMBER: 5107529 SCALE: 1:24  
 REV: \_\_\_\_\_ REV BY: \_\_\_\_\_ DATE: \_\_\_\_\_ SHEET: 1 OF 1